

REGENCY®

CEILING FANS

• CEILING FAN OWNER'S MANUAL •



• OASIS •

5/04

WARNING: Read and follow these instructions carefully and be mindful of all warnings shown throughout.

IMPORTANT SAFEGUARDS:

1. To ensure the success of the installation, be sure to read the instructions and review the diagrams thoroughly before beginning.
2. To avoid possible electric shock, be sure electricity is turned off at the main power box before wiring. All electrical connections must be made in accordance with local codes, ordinances and/or the National Electric Code. If you are unfamiliar with the methods of installing electrical wiring and products, secure the services of a qualified and licensed electrician as well as someone who can check the strength of the supportive ceiling members and make the proper installation(s) and connections.
3. Make sure that your installation site will not allow rotating fan blades to come in contact with any object. Blades should be at least 7 feet from floor when fan is operating.
4. If possible, mount ceiling fan on a ceiling joist - the joist must be able to support the motion and weight of the moving fan. If the fan will be mounted on a ceiling outlet box, an approved box UL listed as “suitable for fan support” is required. The box and its supporting members must be able to support the moving weight of the fan (at least 35lbs.). The box must not be able to twist or work loose. Installation on a concrete ceiling should be performed by qualified personnel.
5. Blades should be attached after motor housing is hung and in place. Fan motor housing should be kept in the carton until ready to be installed to protect its finish. If you are installing more than one ceiling fan, make sure that you do not mix fan blade sets, as each blade is part of a weighted set.
6. After making electrical connections, spliced conductors should be turned upward and pushed carefully up into outlet box. The wires should be spread apart with the common conductor and the grounding conductor on one side of the outlet box, and the “HOT” wires on the other side.
7. Electrical diagrams are for reference only. Light kits that are not packed with the fan must be UL listed and should be installed per the light kit’s installation instructions.
8. After fan is completely installed, check to make sure that all connections are secure to prevent fan from falling and/or causing damage or injury.
9. The fan can be made to work immediately after installation - the bearings are adequately charged with grease so that, under normal conditions, further lubrication should not be necessary.
10. The fan must be turned off and stopped before reversing fan direction.

IMPORTANT SAFETY PRECAUTIONS



*Thank you for choosing a Regency Ceiling Fan. You have chosen the best!
Your new ceiling fan has been designed to provide many years of service and enjoyment.*

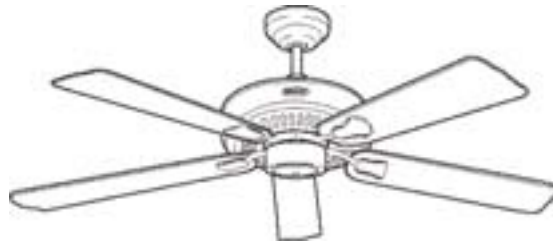

WARNINGS:

- * Disconnect power by removing fuse or turning off circuit breaker before installing the fan.
- * To reduce the risk of fire, electrical shock, or personal injury, mount only to the building's structure. Electrical boxes (unsupported) or joist spanning braces not designed for fan support will not adequately support the fan.
- * To reduce the risk of personal injury, do not bend the blades when installing them, balancing them or cleaning the fan. Do not insert any object(s) between rotating fan blades.
- * Shipping supports have been placed between the motor and fan housing to protect the fan during shipment. These should be removed and discarded after the fan is hung in place.

NOTE:

The important precautions, safeguards and instructions appearing in this manual are not meant to cover all possible conditions and situations that may occur. It must be understood that common sense, caution and care are factors which cannot be built into this product. These factors must be supplied by the person(s) installing, caring for and operating the unit.

TOOLS AND MATERIALS REQUIRED



- Phillips screwdriver
- Blade screwdriver
- Wrench or pliers
- Wire cutter
- Stepladder
- Wiring supplies as required by electrical code

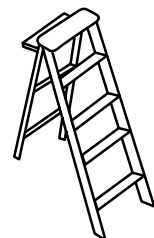
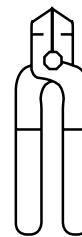
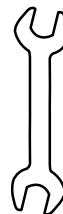
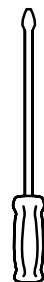
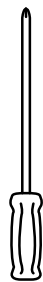

Unpack your fan and check the contents. Do not discard the carton. If warranty replacement or repair is ever necessary, the fan should be returned in original packing. Remove all parts and hardware. Do not lay motor housing on its side, the decorative housing may shift, be bent or damaged.

Examine all parts. You should have the following:

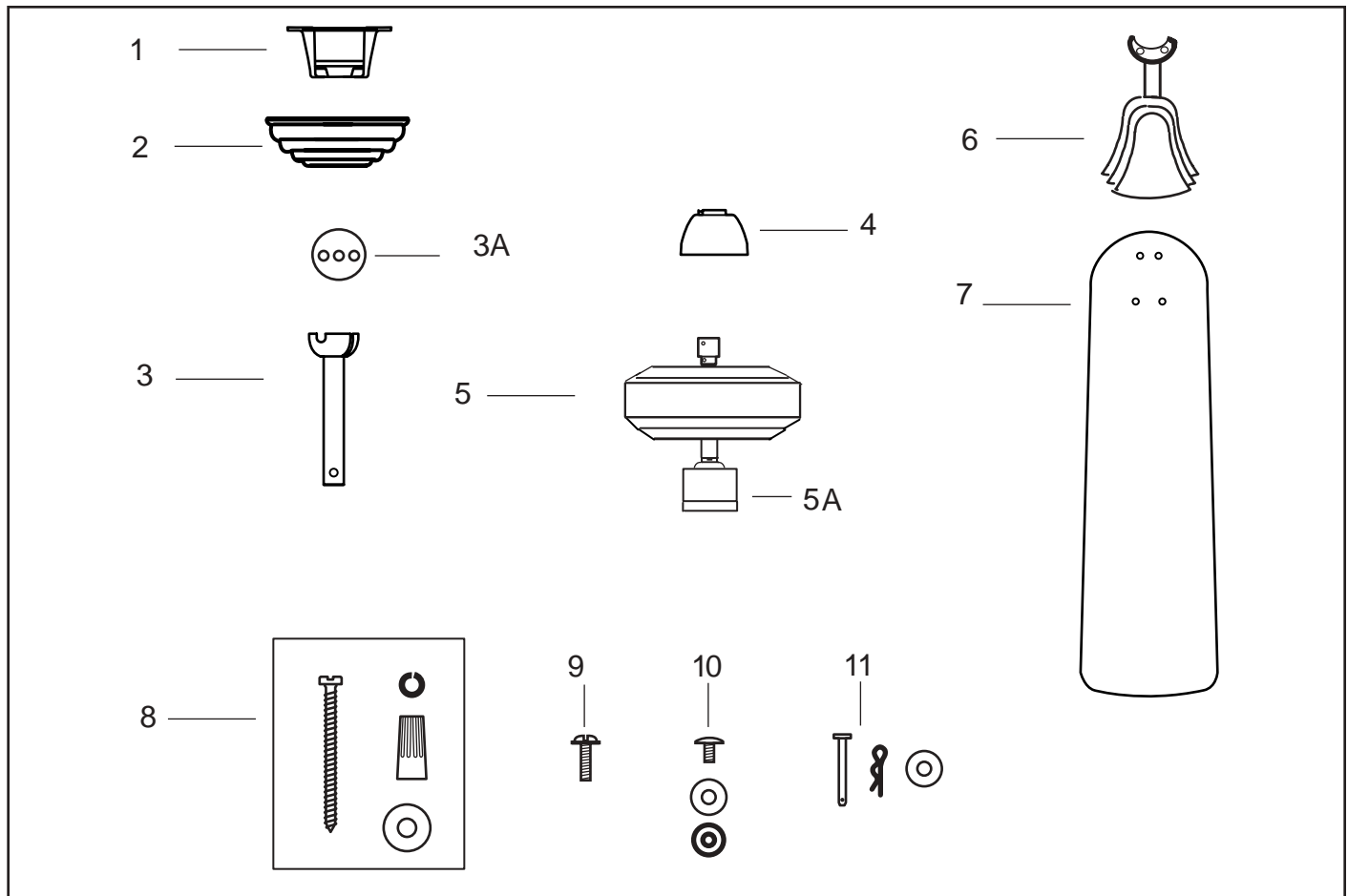

1. Mounting bracket
2. Ceiling canopy
3. Downrod/ball assembly and (3A) ball cover (rubber)
4. Decorative collar cover
5. Fan housing with motor and (5A) detachable switch housing. Remove rubber shipping supports (if included on your fan).
6. Blade arms (5)
7. Fan blade (5)
8. Bracket hardware (wood screws, washers, wire nuts)
9. Blade arm to motor screws
10. Blade arm to blade screws, w/washers
11. Downrod pin, cotter pin, washer

Parts identification on assembled fan

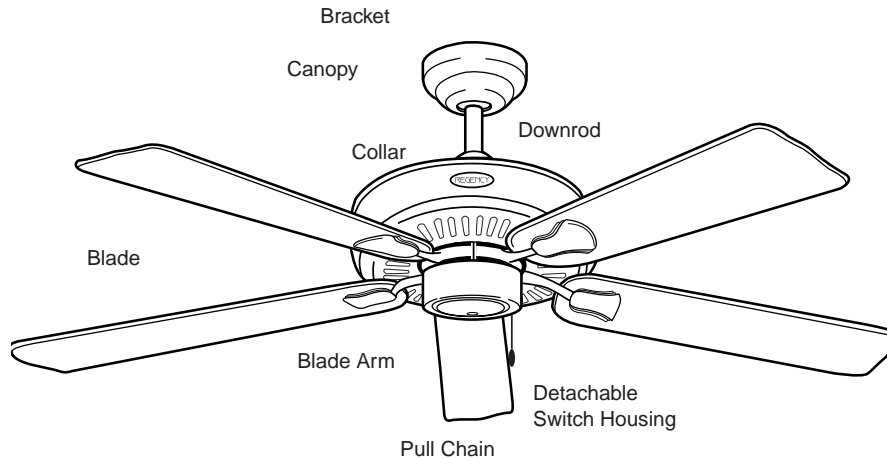

Verify you have all parts before beginning the installation. Check foam insert closely for missing parts. Remove motor from packing. To avoid damage to finish, assemble motor on soft padded surface or use the original foam inset in motor box. Do not lay fan on its side as this could result in shifting of motor in decorative enclosure.

INSTALLING THE MOUNTING BRACKET

Caution: To avoid possible electrical shock, be sure electricity is turned off at the main power box before wiring. All wiring must be in accordance with National and Local Electrical Codes and the ceiling fan must be grounded as a precaution against possible electric shock.

1. Locate ceiling joist where fan is to be mounted, being sure location agrees with the requirements in the minimum clearance safeguards section of the guide. Wood joist must be sound and of adequate size to support 35 lbs. (Pg. 1, #4)
2. If not already present, mount a UL listed outlet box marked "suitable for fan support" following the instructions provided with the outlet box. The outlet box must be able to support a minimum of 35 pounds.
3. Attach hanger bracket to outlet box using screws provided with the outlet box. (Fig. 1)

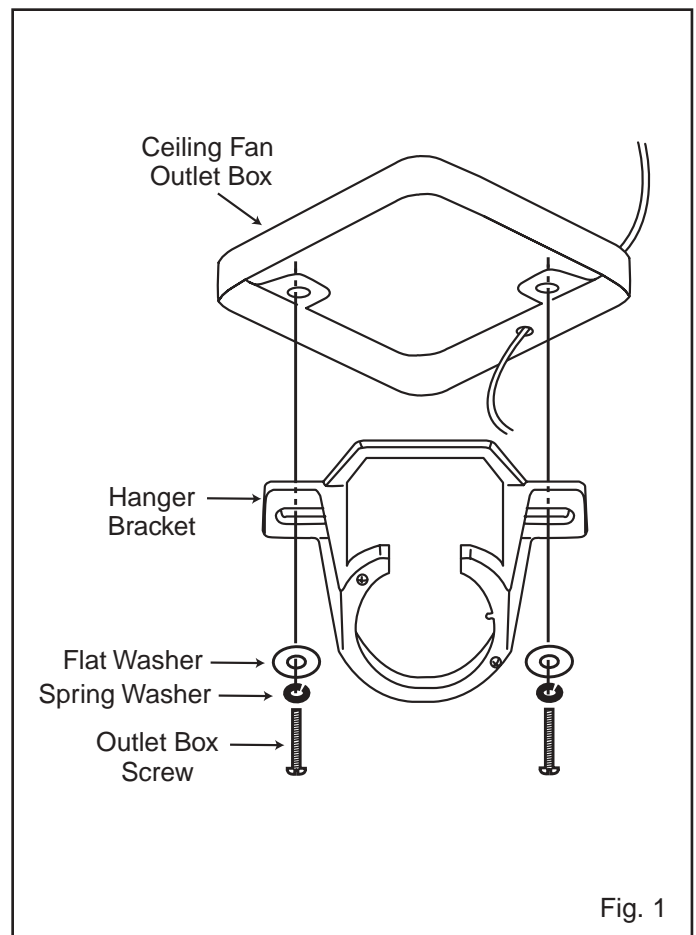

Fig. 1

ATTACHING DOWNROD, CANOPY AND COLLAR COVER (FIG. 2):

1. Carefully support fan body (motor) in its styrofoam packing with the mounting collar (where the wires come out) facing upward.
2. Remove ball from downrod by loosening set screw in the side of the ball. Slide ball down and remove ball pin; remove ball.
3. Feed the wires from top of fan through end of downrod and set end of downrod into mounting collar so the hole in the downrod lines up with the hole in the side of the mounting collar.
4. Insert downrod pin through holes in mounting collar and downrod; slip cotter pin through small hole in end of downrod pin to hold downrod pin in place.
5. Tighten security screws against downrod using a large flat blade screwdriver to ensure a tight fit against downrod. Then tighten lock nuts against mounting collar.

NOTE: Fan has 6 feet of hook-up wire in case you are using a long extension downrod. Wires can be cut so only 8 inches or so extend beyond the top of the downrod to make the electrical connections easier and safer.

6. Feed wires through and slide collar cover down the downrod to top of fan.
7. Feed wires through canopy and slide canopy over downrod to lay on top of collar cover. It will be attached to ceiling later.
8. Feed wires through ball and slide ball over downrod, past hole in the top end of downrod. Insert ball pin (removed in Step 2), slide ball up and tighten set screw to secure ball in place.
9. Feed wire through holes in ball cover and snap ball cover over top of ball.

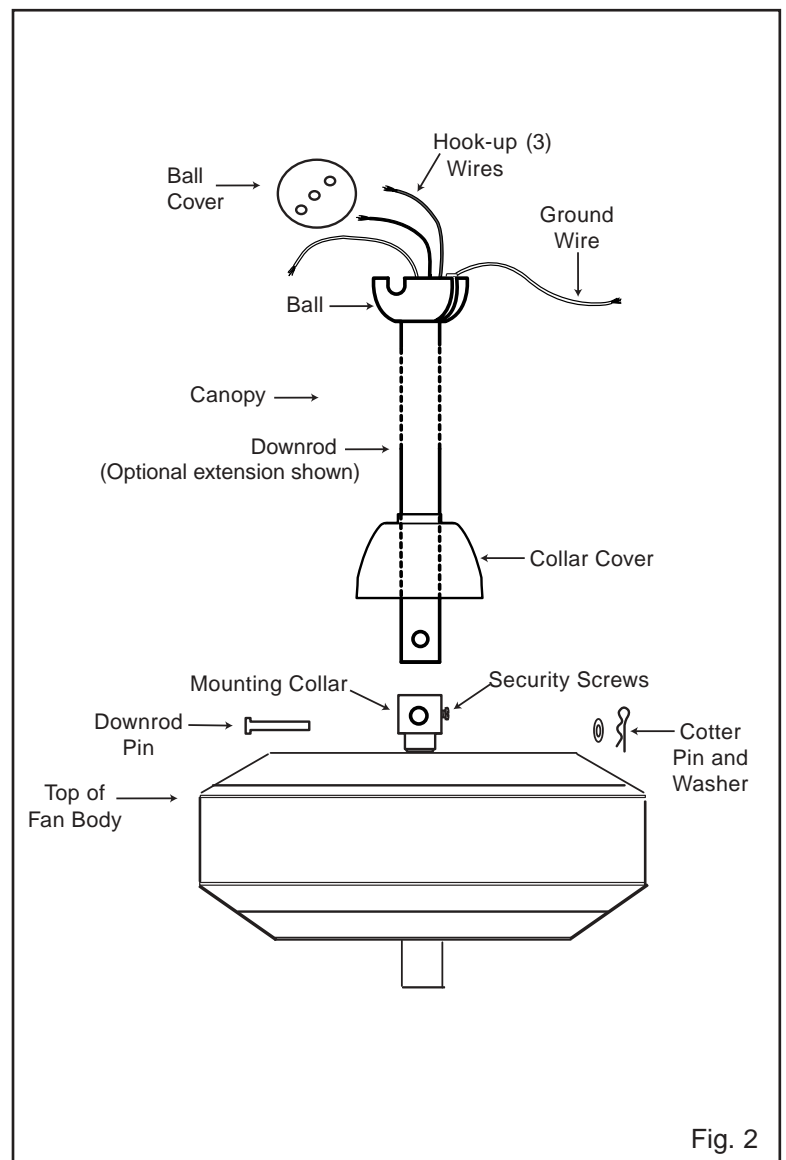
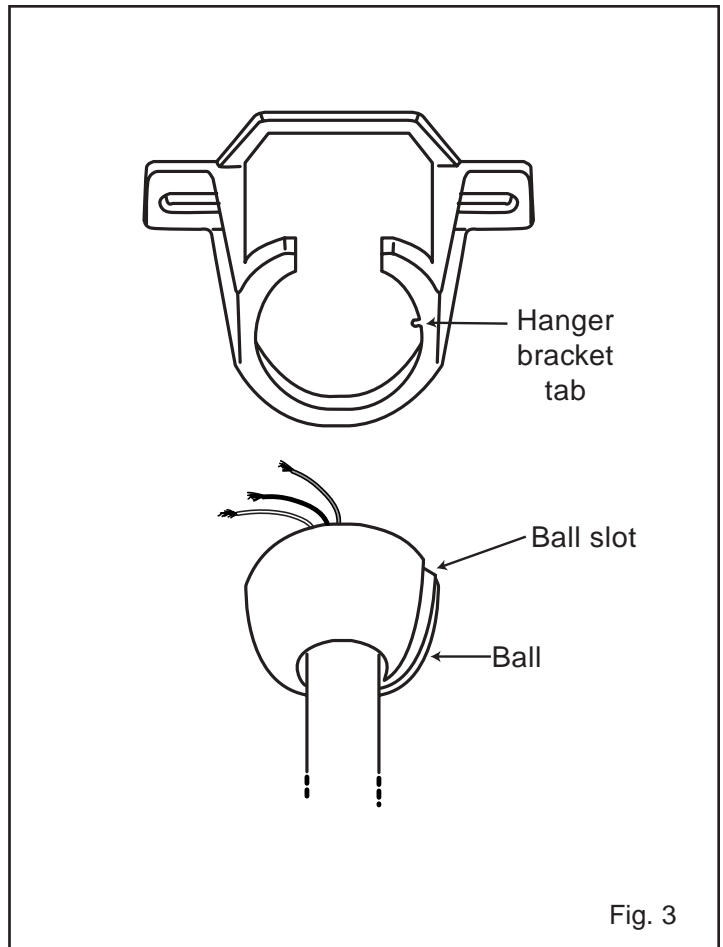

Fig. 2

- *1. Be sure your hanger bracket is secure. The entire weight of the fan will now be hanging from it.
- 2. Lift fan body/downrod/ball assembly into hanger bracket opening.
NOTE: The tab in hanger bracket opening should fit into slot on ball (Fig. 3).
- 3. Make wire connections, (refer to section titled “Electrical Connections” page 7)
- 4. Slide canopy up and fasten to hanger bracket with screws provided AFTER all electrical connections are complete.



WARNING: To avoid damaging the blade arms and blades, do not install onto fan until fan is fastened to ceiling.

ELECTRICAL CONNECTIONS: *Be sure electricity is turned off at the main power box before wiring

- Four wires are connected to the fan.
 - Black - this is the "hot" power to run fan.
 - White - this is the "common" power to run fan and light.
 - Blue - this is the "hot" power for light kit.
 - Green - Ground wire (on bracket or downrod)
- If fan and light are to be connected to the same circuit, black and blue wires can both be connected to house circuit black wire.

NOTE: The other end of the blue wire, (light circuit) is in the switch housing with a wire nut and label for light kit attachment. The white wire (common for light kit) is also there.

WARNING: If light kit is not used, DO NOT connect blue wire.

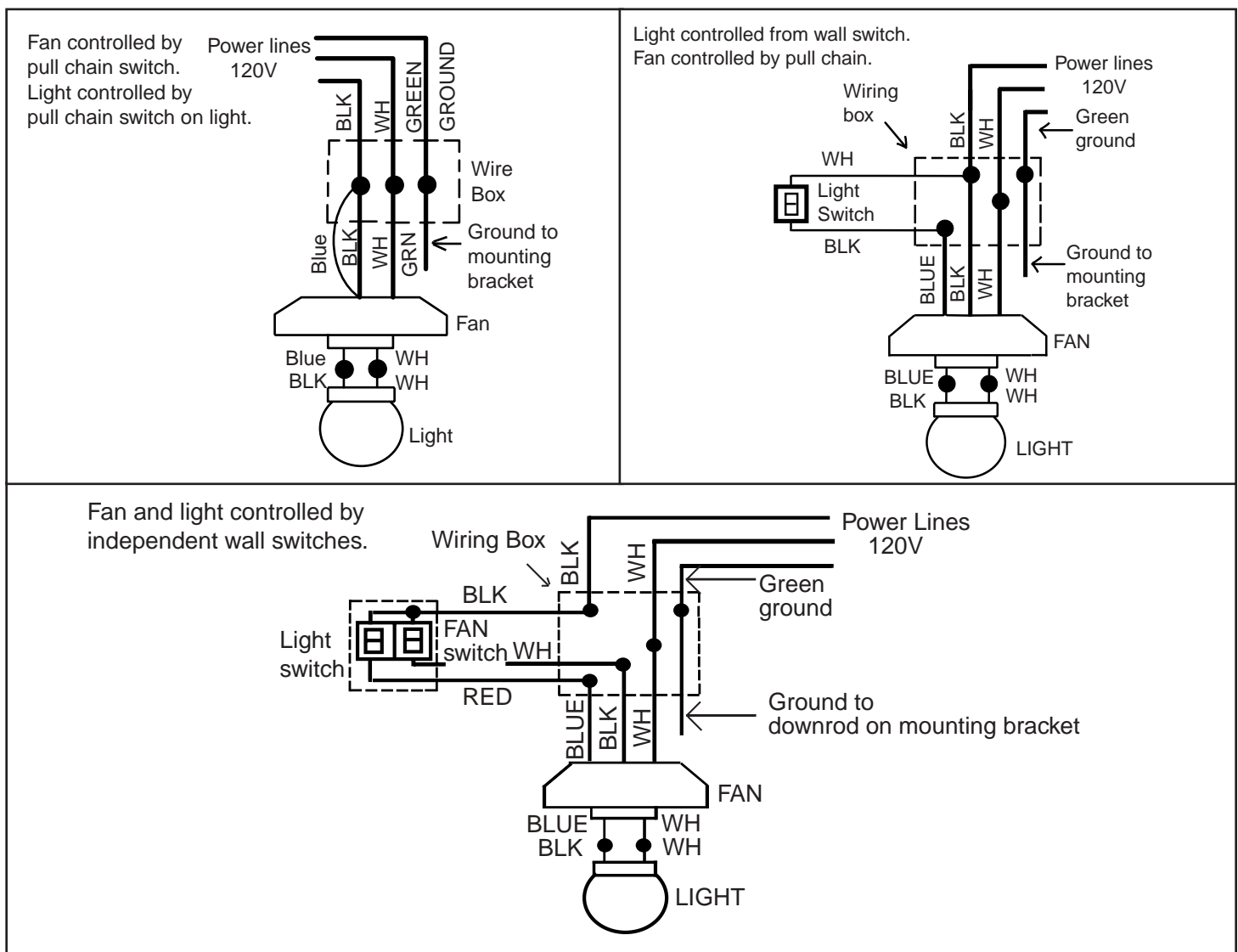

BLADE ATTACHMENT:

1. Place washer on screw. Insert this assembly through the blade and start the screw into the blade arm. Repeat this procedure without tightening the screw until all screws have been started into the blade arm. (Fig. 4).
2. Tighten all screws. Repeat for remaining blade arms/blades.
3. Fasten blade assembly to motor with screws and washers provided. Repeat procedure for remaining blades (Fig. 5). Make sure screws are TIGHT! Loose motor screws can contribute to unnecessary hum during operation.

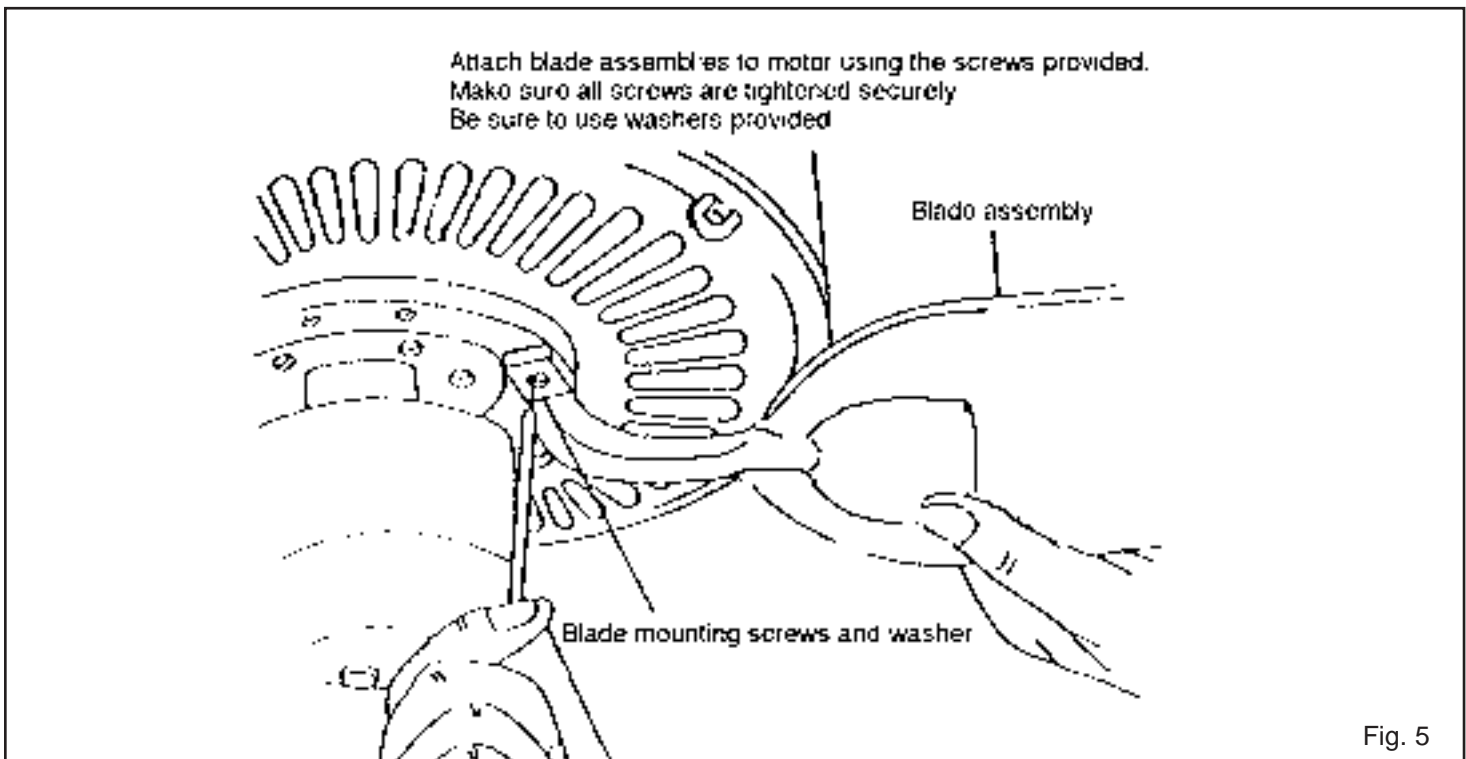
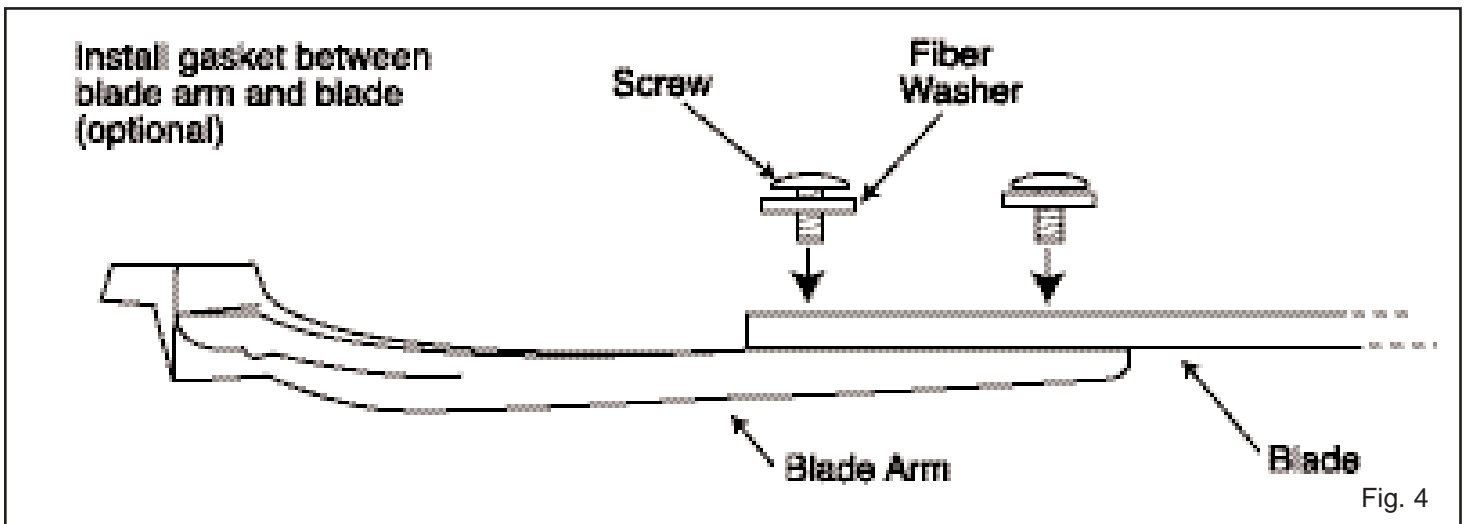

INSTALLATION OF REMOVABLE SWITCH HOUSING



NOTE: Be sure to turn the power off before installing.

1. If installing light kit, attach to switch housing per instructions supplied with light kit. See “Electrical Connections” for hook up of light kit. Carefully remove light kit plug in bottom of switch housing.
2. Connect the plug and receptacle and make sure side buckle snaps in place.
3. Attach the switch housing to switch housing hub by aligning keyhole slots and tabs in both.
4. Align the side screw hole in switch housing hub. Insert and tighten side screw.
5. Turn the power on. Your fan is ready for operation.

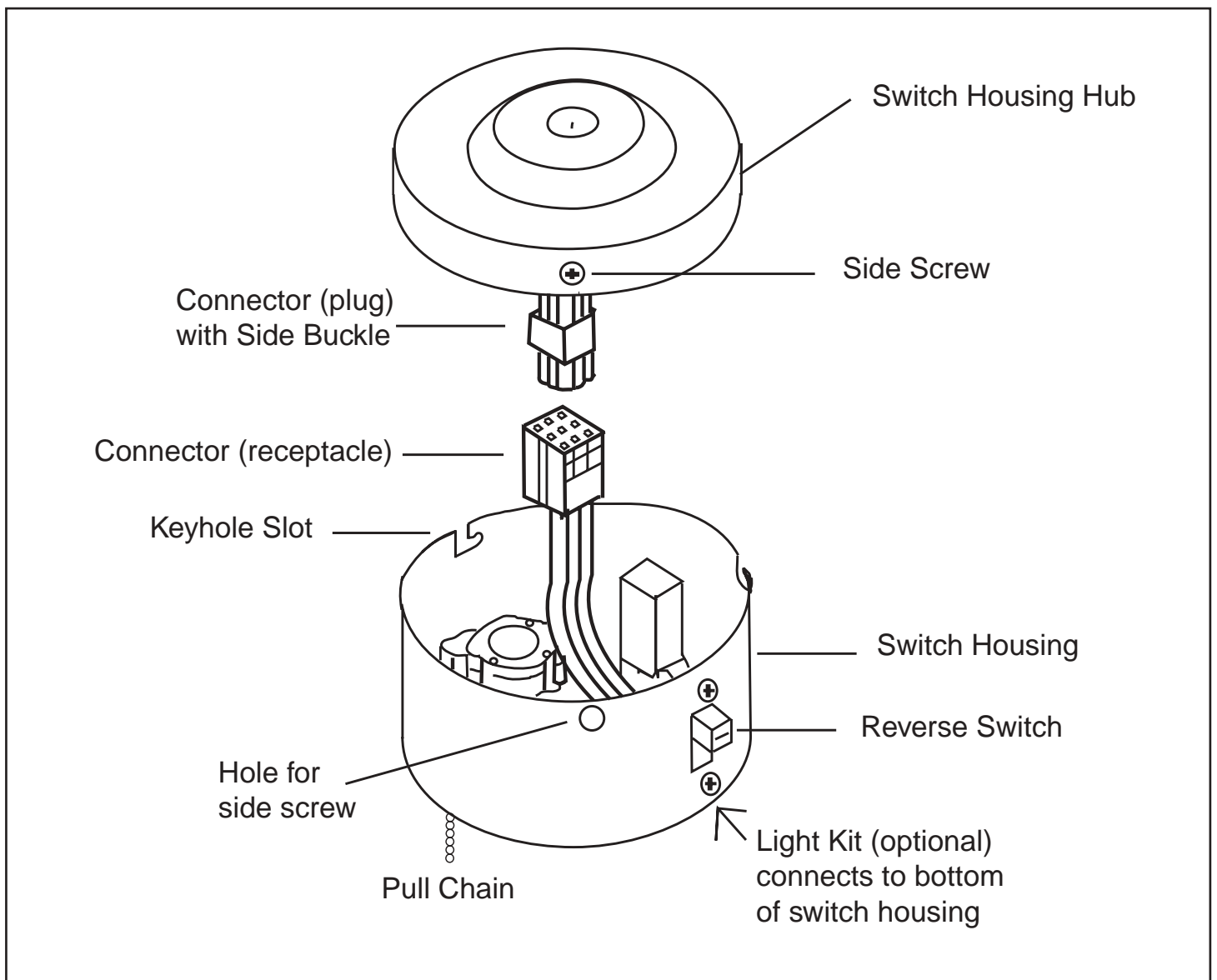

Turn on the power and check operation of the fan. The fan is controlled by the use of the pull chain as follows:

- one pull = high speed
- two pulls = medium speed
- three pulls = low speed
- four pulls = off

For proper functions, ensure that the chain is pulled down fully and released each time.

* Leave fan in “high speed” position when using optional wall control.

The slide switch on the side of the switch housing controls forward or reverse rotation. Make sure switch is not stuck between forward and reverse position (forward is blades rotating counter clockwise, creating a downward air flow).

IMPORTANT: To prevent damage to fan motor when changing direction of rotation, please be sure that fan is off and blades have stopped moving completely before attempting to change direction.

CARE AND CLEANING

Periodically it may be necessary to re-tighten blade to blade arm screws or blade arm to motor screws to prevent clicking or humming sound during operation. This is especially true in climates with broad temperature and humidity ranges.

When dusting the blades, you must support the blade to prevent bending - no pressure should be applied to the blades. If you experience any flaws in the operation of your fan, please check the following points.

TROUBLESHOOTING - IN CASE OF DIFFICULTY

CAUTION: Switch off power supply before carrying out any of these checks.

1. If fan will not start: Check main and branch circuit breakers and/or fuses. Check line wire connections to fan and switch housing wiring. Make sure forward/reverse switch is set to one or the other position, not stuck in between.
2. If fan is noisy: Check and make sure that all screws in motor housing are snug (but not over tight). Check that the screws securing blade arms to the motor are tight. Check that wire connectors in switch housing are not rattling against each other or the interior wall of the switch housing. Check that all glassware is finger tight and that bulb(s) are well held in the sockets, if a light kit is used. Check that the canopy is firmly attached to hanging bracket and not vibrating against ceiling.
3. If fan wobbles: Check that all blades are firmly screwed into blade arms. Check that all blade arms are firmly secure to the motor. Check to make sure that light kit (if present) is firmly attached to switch housing and that all glassware and shades are fastened properly. Wobble can also result from even the smallest deviations in distance from blade tip to blade tip - if measurements from blade tip to blade tip are not equal, loosen screws connecting blade to blade arm one at a time and adjust blade(s) so that distances are equal. Interchanging adjacent blades may redistribute mass and result in smoother operation. Blade arms can be bent slightly to restore same pitch to all blades if a blade is different than the other blades when viewed edge on. Most wobble can be traced to a loose electrical box or mounting bracket. Make sure these are tight and the ball is completely seated in the bracket.

THANK YOU FOR PURCHASING A REGENCY CEILING FAN.

Write to us at:

Regency Ceiling Fans

P.O. Box 730

Fenton, MO 63026

Visit us on the Web at: www.regencyfan.com